

# **IQBoard ET Pro & ET-D Pro V7.0**

## **User Manual**



Copyright (C) 2003-2011 Fuzhou Returnstar Technology Co., Ltd.

Websites: [www.recoverystar.com](http://www.recoverystar.com); [www.iqboard.net](http://www.iqboard.net)

Tel: 0086-591-87274373

Fax: 0086-591-87274383

E-mail: [master@recoverystar.com](mailto:master@recoverystar.com)

## **Statement**

This manual is for IQBoard ET Pro V7.0 and IQBoard ET-D Pro V7.0.

Both Whiteboard and Interactive Whiteboard in this manual refer to IQBoard ET Pro V7.0 or IQBoard ET-D Pro V7.0.

Use this product strictly according to detailed operation instruction in this manual so as to ensure proper use. Please read this manual carefully before you install this product.

Opening the package means you have agreed to purchase this product, Returnstar will not accept returns of opened packages.

The product specification may be subject to change without prior notice. The sample pictures in this User Manual may differ from the real product.

Returnstar reserves all rights to charge the fee at anytime for product replacement, revision and update. The information in this manual is subject to regular change without prior notice. Returnstar will make no warranties with respect to this product and disclaims any warranties, whether express or implied, of merchantability and fitness for a particular purpose.

## **Trademark Notice**

Returnstar and IQBoard are registered trademarks of Fuzhou Returnstar Technology Co., Ltd.. Windows is a registered trademark of Microsoft Corporation.

## **Recycling**

Always return your used electronic products, batteries, and packaging materials to separate collection. This way you help prevent uncontrolled waste disposal and promote the recycling of materials.

## **Temperature and Humidity Requirements**

### *Storage*

Temperature: -40°C ~ 60 °C      Humidity: 0% ~ 95%

### *Operation*

Temperature: 0°C ~ 40 °C      Humidity: 15% ~ 85%

# TABLE OF CONTENTS

STATEMENT .....	2
TRADEMARK NOTICE .....	2
RECYCLING .....	2
TEMPERATURE AND HUMIDITY REQUIREMENTS .....	2
CHAPTER 1 PRODUCT INTRODUCTION .....	5
CHAPTER 2 SPECIFICATIONS.....	6
2.1 PERFORMANCE .....	6
2.2 HOTKEYS .....	6
2.3 FLEXIBLE FIXING AND RELOCATING METHODS .....	6
2.4 DURABLE SURFACE, SOLID BODY .....	6
2.5 PC CONNECTION.....	7
2.6 ABOUT MODEL .....	7
2.7 SYSTEM REQUIREMENTS.....	7
CHAPTER 3 HOW TO INSTALL IQBOARD.....	8
3.1 MOUNT WHITEBOARD .....	8
3.1.1 For Product with an "M" in Its Hardware SN.....	8
3.1.2 For Product with a "Y" in Its Hardware SN.....	10
3.2 HOW TO INSTALL BATTERY OF ELECTRONIC PEN .....	17
3.3 HOW TO REPLACE ELECTRONIC PEN TIP .....	18
3.4 HOW TO INSTALL BATTERY OF ELECTRONIC WAND .....	19
CHAPTER 4 HOW TO CONNECT TO COMPUTER AND PROJECTOR.....	20
4.1 WIRED CONNECTION .....	20
4.2 WIRELESS CONNECTION.....	20
CHAPTER 5 HOW TO INSTALL AND UNINSTALL DRIVER.....	22
5.1 HOW TO INSTALL DRIVER .....	22
5.2 HOW TO UNINSTALL DRIVER .....	22
CHAPTER 6 HOW TO SETUP IQBOARD .....	23
6.1 ORIENTATION .....	23
6.2 HOTKEY SETTINGS .....	24
CHAPTER 7 HOW TO USE IQBOARD .....	26

7.1 BASIC OPERATIONS .....	26
7.2 HOW TO USE BUTTONS ON ELECTRONIC PEN .....	27
7.2.1 <i>Settings on Button Functions</i> .....	27
7.2.2 <i>Default Options</i> .....	28
7.2.3 <i>Customized Options</i> .....	28
7.3 HOW TO USE FREQUENTLY USED SOFT HOTKEYS .....	29
<b>CHAPTER 8 FAQ .....</b>	<b>31</b>
<b>CHAPTER 9 CAUTIONS AND MAINTENANCE.....</b>	<b>34</b>
9.1 WHITEBOARD .....	34
9.2 USB CABLE .....	35
9.3 PROJECTION .....	35
9.4 TRANSPORT .....	35
9.5 PART REPLACEMENT .....	35

# Chapter 1 Product Introduction

IQBoard ET Pro V7.0 and IQBoard ET-D Pro V7.0 are the latest interactive presentation whiteboards. Connect IQBoard ET Pro/ET-D Pro V7.0 with your computer and projector, then simply touch the projection area with Electronic Pen, you can transform Electronic Pen to Mouse and directly operate the computer on the projection area. If you use IQBoard ET-D Pro V7.0, you can enter Dual-user Mode in IQBoard Software to allow two users to operate simultaneously on the board.

With IQBoard ET Pro V7.0 or IQBoard ET-D Pro V7.0 and IQBoard Software V5.0, marvelous interactive communicating effects can be achieved in live demonstration, teaching, product exhibition, business conference, video communication, news broadcast, securities evaluation, military command, entertainment, medical consultation, engineering design, competition tactics analysis, weather analysis, etc.

IQBoard ET Pro V7.0 and IQBoard ET-D Pro V7.0 are provided with powerful IQBoard Software V5.0, which makes your operation on interactive whiteboard more convenient. Through IQBoard Software V5.0, various interactive teaching and demonstrating functions can be achieved, such as write, erase, label (in character, line, dimension and angle), drag, zoom, reveal screen, spotlight, screen capture and save, screen record and playback, handwriting recognition, on-screen keyboard, text input, text to speech, hyperlink to video, sound and webpage, and remote conference by NetMeeting. IQBoard Software V5.0 also has colorful object animation effects, page switching effects and interactive questions. Therefore, with IQBoard Software V5.0, users can make more interactive courseware by designing unique object animation, adding sound or hyper linking.

IQBoard Software V5.0 also includes 500M IQBoard Resource Library covering more than 30 subjects, such as math, physics, chemistry, biology, gymnasium, etc. User can customize the installation by selecting subjects. The software also provide common line, shape, character, symbol, decoration graph, background template, Flash courseware, and other resources. Moreover, the software supports importing various picture files and DOC(X), PPT(X), XLS(X), PDF files. The page and file created by IQBoard Software can be saved as and freely converted to various picture files as well as DOC(X), PPT(X), XLS(X), PDF, html files, etc.

We provide continuous upgrading service for IQBoard Software. For more information and detailed operation about IQBoard Software, please refer to IQBoard Software V5.0 User Manual in the installation CD.

# Chapter 2 Specifications

## 2.1 Performance

<b>Resolution</b>	21300×12000, 600dpi	<b>Precision</b>	0.05mm
<b>Signal Tracking Rate</b>	8m/s	<b>Signal Processing Rate</b>	480 dots/s
<b>Orientation</b>	4, 9 or 20 points	<b>Power Consumption of Electronic Pen &amp; Wand</b>	≤6 mW

## 2.2 Hotkeys

28 virtual/soft hotkeys are provided to achieve frequently used functions of IQBoard Software, 14 on each side of whiteboard surface.



**Note:** When you use virtual/soft hotkeys, you need to set these hotkeys at the first time you use the interactive whiteboard.

## 2.3 Flexible Fixing and Relocating Methods

Fixing methods include wall hanging, cabinets and mobile stand. Provide optional height adjustable mobile stand for 50-120 inch whiteboards, the height can be adjusted from 1.88m to 2.12m.

## 2.4 Durable Surface, Solid Body

The surface adopts dedicated writing film made of DuPont anti-abrasive coating. It features with anti-scratch, high luminance, high definition, easy cleaning (can be cleaned by whiteboard detergent or wet cloth), and can completely eliminate bright spots. The backboard, which is resistant to distortion, expansion and shrinkage, adopts PS board with high density. Model supporting normal pen writing is also provided.

## 2.5 PC Connection

### Connection Way 1:

Standard: 10m USB cable for connecting IQBoard with PC, external power is not required.

Optional: USB signal amplifier to extend the USB cable to 20m and 2.4G radio frequency wireless module with 25m effective transmission distance.

### Connection Way 2:

Standard: 5m USB cable for connecting IQBoard with PC, external power is not required.

Optional: 5m USB cable to extend the standard 5m USB cable to 10m and 2.4G radio frequency wireless module with 25m effective transmission distance.



**Note:** Each board can only support one of these connection way when product. Please do not miss use these two connection ways.

## 2.6 About Model

AP050, AP060, AP080 and AP100 refer to IQBoard ET Pro in relevant sizes. ADP050, ADP060, ADP080 and ADP100 refer to IQBoard ET-D Pro in relevant sizes. B means wireless connection. N means hotkeys and pen tray are not included. W means board surface supports normal pen writing. For example, ADP080VHBNWY means 80 inch IQBoard ET-D Pro adopting wireless connection, without hotkeys and pen tray, and supporting normal pen writing.

## 2.7 System Requirements

Windows XP/2003/Vista/7

Pentium166 CPU (Pentium II or higher recommended)

64MB RAM (128MB recommended)

1G free hard disk space (for full installation)

1 free USB port

1 projector (short throw or ultra-short throw projector recommended)





# Chapter 3 How to Install IQBoard

## 3.1 Mount Whiteboard

### 3.1.1 For Product with an “M” in Its Hardware SN

In case your product has an “M” in its hardware SN, you can select wall mounting.

#### Parts list

Picture	Name	Quantity
	Screw	4
	Wall Anchor	2
	Safety Bracket	2
	Anchor Bolt	2
	Wall Mounting Bracket (already mounted on the backboard)	2

#### Installation steps

Step 1. Determine the installation height of the Anchor Bolt (190cm above floor), then measure the horizontal distance (70cm±3mm usually) of the 2 holes on the Wall Mounting Brackets according to the location of the whiteboard. *(Note: You'd better take the actual horizontal distance of the 2 holes on the backboard as standard.)* Drill a hole at both ends, then screw the 2 Anchor Bolts into the holes and leave 4mm clearance between bolt head and nut (as shown in the figure below).

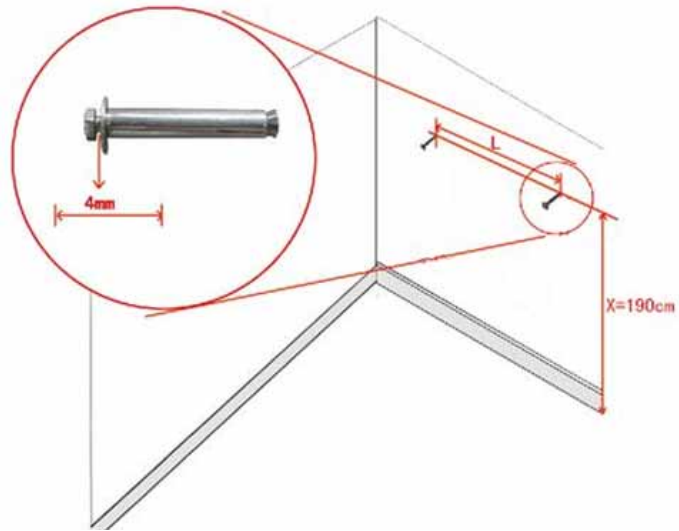

Step 2. Align the Wall Mounting Brackets on the backboard with the Anchor Bolts, and hang the whiteboard on the wall.



Step 3. Fasten the 2 Safety Brackets on each side of whiteboard lower frame with 2 Screws. According to the location of the Safety Brackets, drill 2 mounting holes on the wall. Finally, use Wall Anchors and Screws to fix the Safety Brackets on the wall.

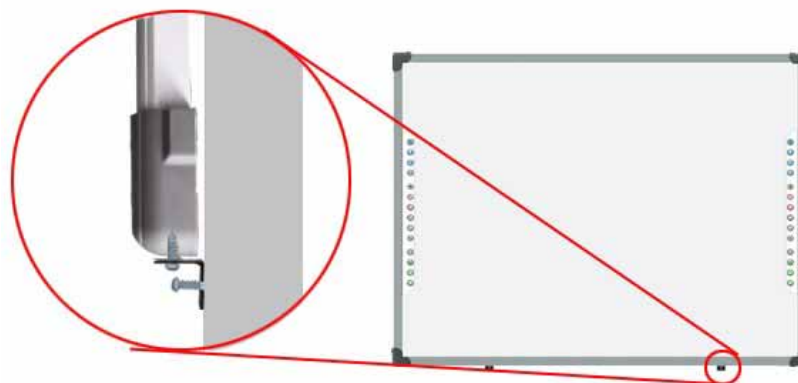





### 3.1.2 For Product with a “Y” in Its Hardware SN

In case your product has a “Y” in its hardware SN, you can select either wall mounting or stand mounting.

#### 3.1.2.1 Wall Mounting

##### Parts list

Picture	Name	Quantity
	Screw	4
	Wall Anchor	2
	Safety Bracket	2
	Anchor Bolt	4
	Height Adjustable Bracket (already mounted on the backboard)	4

##### Installation steps

Step 1. Drill 4 holes at the location where you want to place the 4 Anchor Bolts, insert the 4 Anchor Bolts in these holes, and leave 4mm clearance between bolt head and nut for hanging whiteboard.

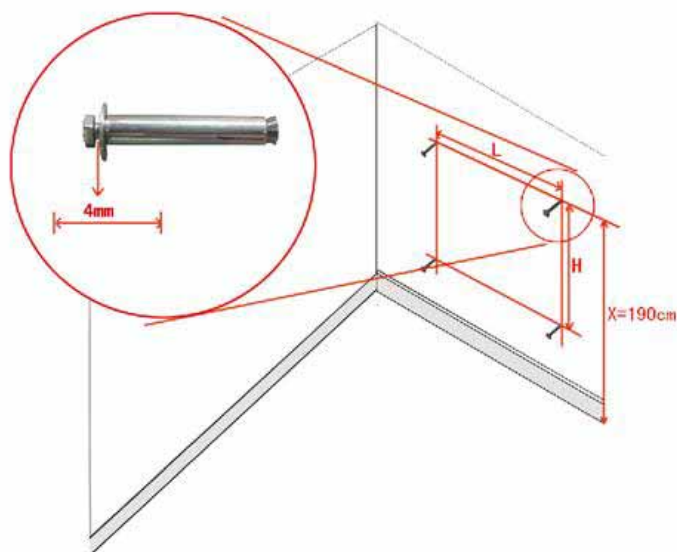



**Note:** The distance from floor to the 2 Anchor Bolts on top (Distance X) is 190cm. The vertical distance between 2 Anchor Bolts (Distance H) is 45cm for 50" and 60" whiteboards, and 75cm for 80" and 100" whiteboards. For the horizontal distance between 2 Anchor Bolts (Distance L), please measure horizontal distance of the 2 Height Adjustable Brackets on the backboard.

Step 2. Align the Anchor Bolts with the clip holes of Height Adjustable Bracket on the backboard, and then hang the whiteboard on the wall.

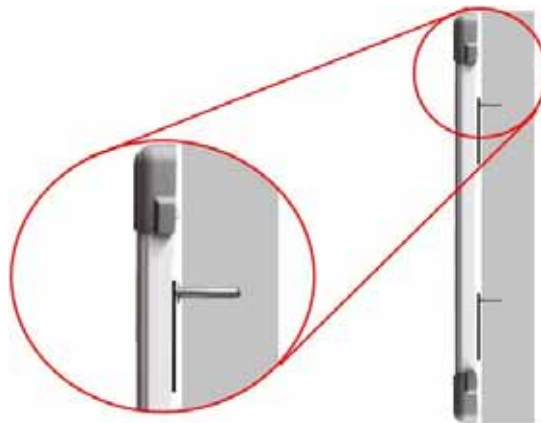

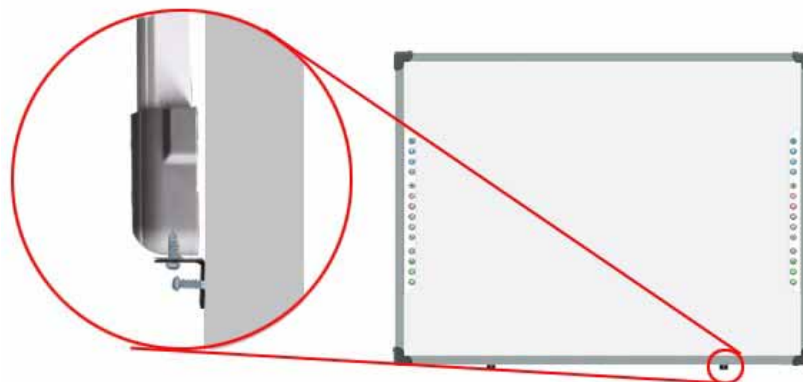

Step 3. Fasten the 2 Safety Brackets on each side of whiteboard lower frame with 2 Screws. According to the location of the Safety Brackets, drill 2 mounting holes on the wall. Finally, use Wall Anchors and Screws to fix the Safety Brackets on the wall.



### 3.1.2.2 Stand Mounting

#### Parts list

Picture	Name	Quantity
	Leg Bar	2
	Column	2
	Supporting Bar	2
	Caster	4
	Moveable Crossbeam (each includes 2 Beams and a U-shaped Groove; for 100" whiteboard, Beams and U-shaped Grooves are especially lengthened)	2
	Hexagon Bolt A	2
	Hexagon Bolt B (M8×50, with 08/22 washer)	4
	Hexagon Bolt C (M8×50)	8
	Hexagon Bolt Set A (M8×50) (each set includes: 1 hexagon bolt, 1 wind nut, 1 M8 nut, 1 small washer and 1 big washer)	6

	<p>Hexagon Bolt Set B (M8×35) (each set includes: 1 hexagon bolt, 1 wind nut, 1 small washer and 1 big washer)</p>	<p>4</p>
	<p>Anchor Bolt (M8×60)</p>	<p>4</p>
	<p>Open-end Wrench</p>	<p>1</p>

### Installation steps

Step 1. Install Column on each Leg Bar with Hexagon Bolt B.



Step 2. Install one end of each Supporting Bar on each Leg Bar, using Hexagon Bolt A.

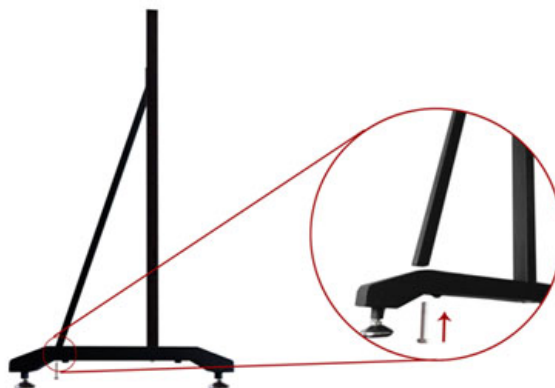

Step 3. Install the other end of each Supporting Bar on each Leg Bar, using Hexagon Bolt Set A. In this stage, please partially screw the bolt, leaving 4mm clearance between bolt head and Column for hanging whiteboard.

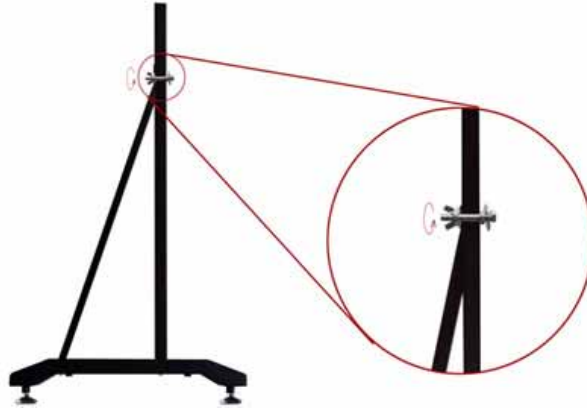

Step 4. Install 2 Casters on each Leg Bar.

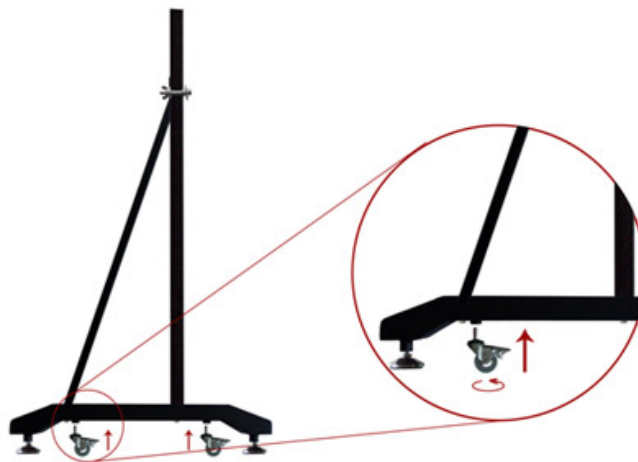

Step 5. Install 2 Beams on each Column, using Hexagon Bolt C.

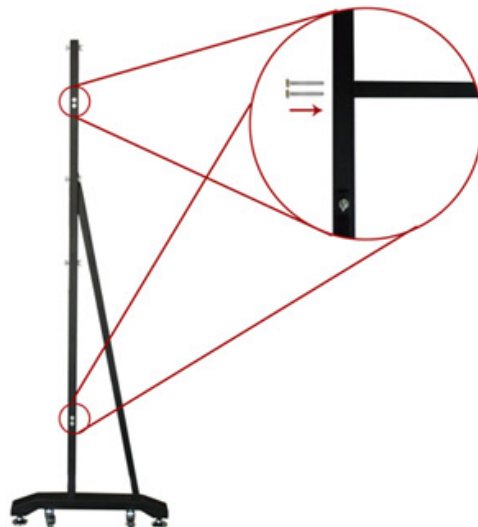

Step 6. Lay down and connect the 2 leg assemblies with the U-shaped Grooves.



Step 7. Secure the U-shaped Grooves with Hexagon Bolt Set B. In this stage, do not completely tighten the bolt in order to adjust the stand width later.

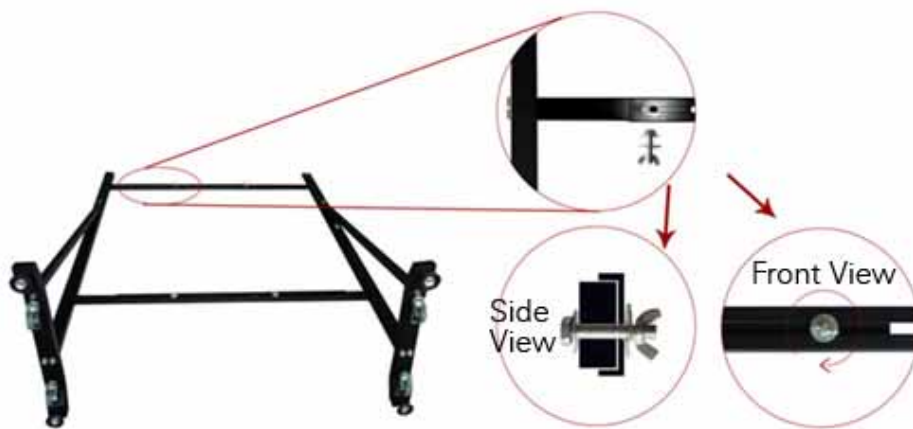

Step 8. Install 2 Hexagon Bolt Sets A on each Column, leaving 4mm clearance between bolt head and nut for hanging whiteboard.

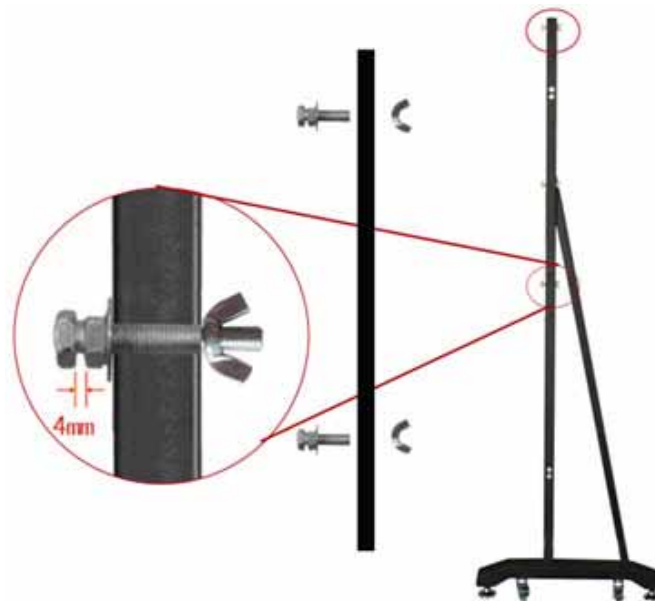

Step 9. Align the Hexagon Bolt on the Column with the clip holes of Height Adjustable Bracket on the backboard, and hang one side of whiteboard on the stand. Then adjust

the stand width to fit the whiteboard, and hang other side of the whiteboard on the stand. Finally, tighten the bolts on the U-shaped Groove and Columns.



**Note:**

1. You can use different clip holes of the Height Adjustable Bracket to adjust the whiteboard height. Generally the bottom of the whiteboard should be 75-80cm above the ground.
2. For 50" and 60" whiteboards, you can hang the whiteboard on the first and second bolts from top down on the Column. For 80" and 100" whiteboards, you can hang the whiteboard on the first and third bolts from top down on the Column.

Fully assembled whiteboard is as follows:



### 3.2 How to Install Battery of Electronic Pen

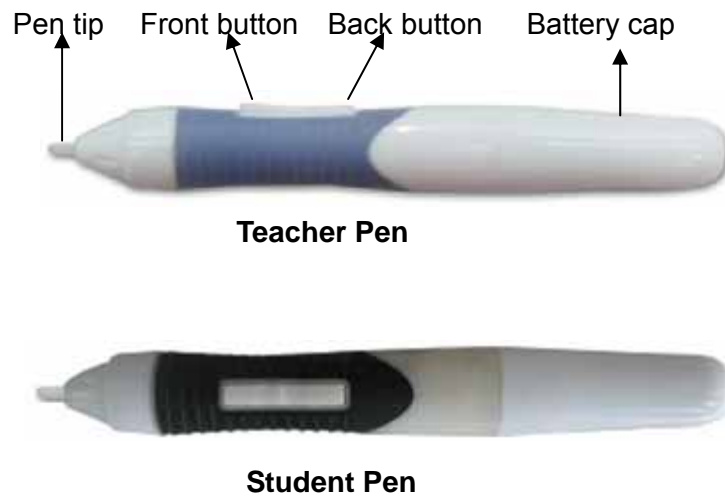

 **Note:**

1. Student Pen is only for IQBoard ET-D Pro V7.0 Interactive Whiteboard.
2. On how to use front/back buttons on Electronic Pen, please refer to 7.2 content.

Step 1. Unscrew the battery cap by turning it counterclockwise.



Step 2. Insert 1 AAA battery with the plus (+) side up.



Step 3. Screw the battery cap back by turning it clockwise.

### 3.3 How to Replace Electronic Pen Tip

Step 1. Unscrew the pen tip cap by turning it counterclockwise.



Step 2. Replace the pen tip by inserting its concave end into the pen body.



Step 3. Screw the pen tip cap back by turning it clockwise.

### 3.4 How to Install Battery of Electronic Wand



Step 1. Gently lift the battery cover to open it.



**Note:** Please gently open the battery cover to avoid damaging the connecting line.

Step 2. Insert 1 AAA battery with the plus (+) side up.



Step 3. Close the battery cover.





**Note:** If the electronic pen or wand will not be used for a long time, please remove the battery.

# Chapter 4 How to Connect to Computer and Projector

## 4.1 Wired Connection

After fixing the whiteboard, please plug USB Standard-B into Standard-B Receptacle on the controller which is at lower left corner of the backboard (when you face to the backboard) and Standard-A Plug into an available USB port of computer, as follows. External power supply is not required. And please connect the projector to the VGA port of your PC video card.

	
USB Standard-A Plug for connecting computer	USB Standard-B Plug for connecting whiteboard

## 4.2 Wireless Connection

If your product is with a “B” in its hardware SN (refer to “[2.7 About Model](#)” for detailed explanation for product model), you can also use Wireless Module for PC connection. The connecting steps are as follows:



**Note:** Please differentiate our hardware SN from software SN. The hardware SN is for the whiteboard, whereas the software SN is for IQBoard Software. You can find the hardware SN on the packing box, backboard and controller. The hardware SN is for you to register to postpone the Warranty period of the board from 3 years to 5 years, but you need remember to register within 4 months upon the date when the board is departed from our factory. You can find the software SN on CD. The software SN is for you to register IQBoard Software.

Step 1. After fixing the whiteboard, insert the round terminal of the 5V transformer into a round jack on the controller, and insert the power plug of the 5V transformer into a power socket.



Step 2. Plug the following wireless adapter into an available USB port of computer. And please connect the projector to the VGA port of your PC video card.



**Note:**

- 1.USB extender is strongly recommended if the distance between computer and whiteboard is too far or there are many obstacles (such as table, platform, etc.). Please plug one end of USB extender into an available USB port of computer, and the other into the wireless adapter, meanwhile, keep the wireless adapter away from any obstacle.*
- 2.When using wireless connection way, you can try to stick aluminized paper onto controller in case there's interference.*

Start the projector after connection, and adjust it to make its projection within the active area and centered. Then use the trapezoid rectification function of the projector to make the projection quadrate.

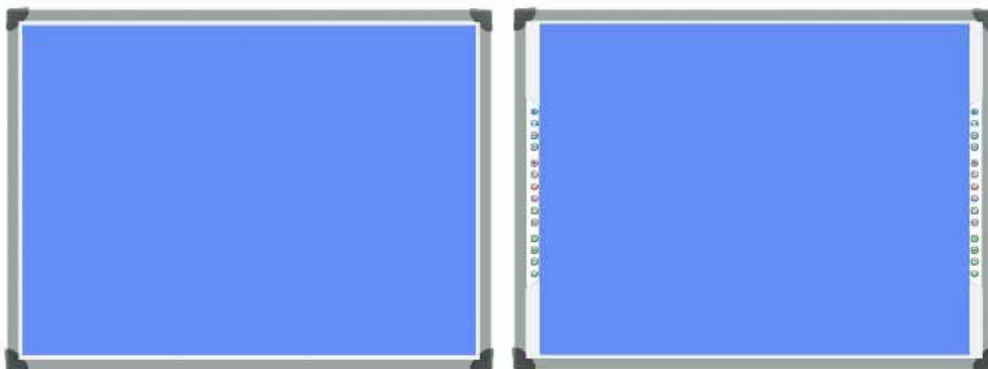

Maximum projection area for whiteboards without hotkeys

Maximum projection area for whiteboards with soft hotkeys

The blue areas are the maximum projection areas. For whiteboards without hotkeys, there should be 2cm margin between projection area and whiteboard inner frame. For whiteboards with soft hotkeys, the projection area should not exceed the hotkeys.



**Note:**



- 1. In case you use 16:9 whiteboard, please choose the projector supporting the 16:9 projection mode.*
- 2. The projection image must be within the active area of the whiteboard, otherwise the whiteboard cannot work normally.*

# Chapter 5 How to Install and Uninstall Driver

## 5.1 How to Install Driver

Run “IQBoard ET Pro & ET-D Pro Drivers.exe” in the installation CD, and install the drivers according to the prompt. The computer will automatically find a new hardware and install the driver.

After the installation is completed, if the indicator beside the USB connecting port turns green, the whiteboard can be used normally. If the indicator turns red, it means the USB cable is not well connected, please re-connect the USB cable or restart the computer. If the indicator is not lighting, it means the USB cable is not connected.

		
Indicator is not lighting	Indicator turns red	Indicator turns green
USB cable is not connected	USB cable is not well connected, or the driver is not correctly installed	The whiteboard works normally



**Note:**

1. If it is the first time you connect the computer to the whiteboard, and the driver is not installed, the system will prompt “Found New Hardware”, you can ignore or close the prompt, and continue to install the driver according to the above steps.
2. You can install the driver under any Windows user account (Administrator, Guest, or Limited User).

## 5.2 How to Uninstall Driver

Select “Start > Programs > IQBoard ET Pro & ET-D Pro Drivers > Uninstall” to uninstall. You can also open Control Panel, select “Add/Remove Programs”, and in the list of currently installed Programs, select “IQBoard ET Pro & ET-D Pro Drivers”, then press the “Change/Remove” button to remove the driver.

# Chapter 6 How to Setup IQBoard

## 6.1 Orientation

At the first time you use IQBoard, you need to orient it, so the moving track of the electronic pen or wand can match the cursor. You can select 4 points, 9 points or 20 points orientation. Normally 9 points orientation is adopted. After the whiteboard is oriented, you don't need to re-orient under the same environment.

Please do as following steps when you orient the whiteboard:

Step 1. Select "Start > Programs > IQBoard ET Pro & ET-D Pro Drivers > Orient" or press  on the hotkey bar if your whiteboard is with soft hotkeys. Then the Orientation Points Selection window appears as follow.

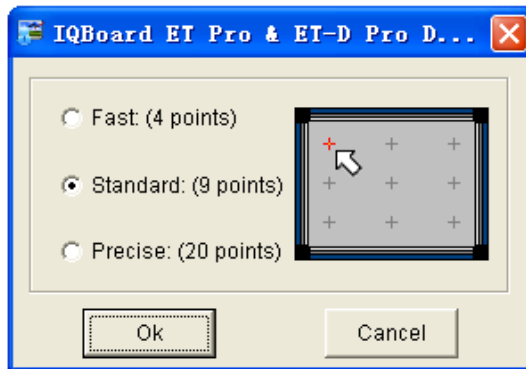

Step 2. Select one of the Orientation Points and click "OK", the Orientation interface appears as follow.



Step 3. Do one of the followings:

If you use pen or wand, follow the on-screen instructions, press the center of each cross accurately with the pen tip.

If you use Electronic Wand, follow the on-screen instructions, press the center of each cross accurately with the wand tip and press the button on the wand body.

Your whiteboard is now oriented.



**Note:**

- 1. If you did not locate the accurate central point or clicked the wrong point, or the next fixed point appeared without press, please press "ESC" on the keyboard to exit orientation and re-orient. Otherwise you can't operate the whiteboard accurately.*
- 2. Please make your Electronic Pen or Wand upright when orienting.*
- 3. In case the relative position of the whiteboard and projector is changed, or the driver or the monitor resolution is altered, please re-orient.*

## 6.2 Hotkey Settings

At the first time you use the whiteboard with soft hotkeys, you need to set these hotkeys.

Step 1. Select "Start > Programs > IQBoard ET Pro & ET-D Pro Drivers > Hotkey Settings" to enter the setting window as follow.

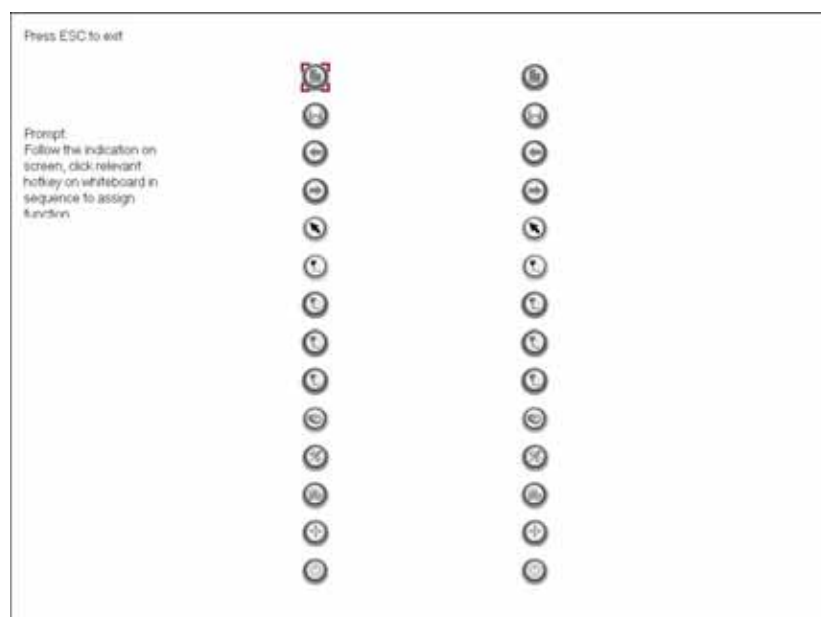

Step 2. Follow the indication on screen, click relevant hotkey in sequence. After the setting

is completed, you can use these hotkeys.

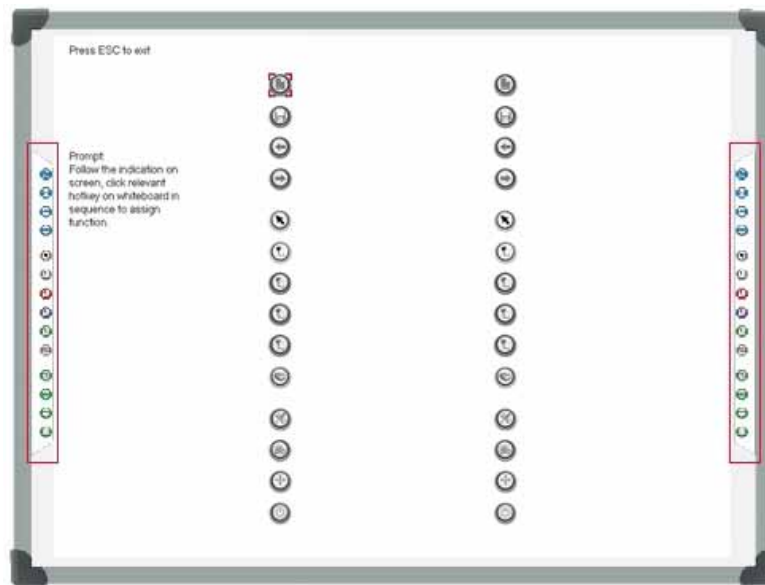

**Note:**

1. When setting the soft hotkeys, if some error occurs, you can press “ESC” key on the keyboard to exit the setting process, and then reset the hotkeys.
2. On how to use the frequently used soft hotkeys, please see the following [7.3](#) content.

# Chapter 7 How to Use IQBoard

## 7.1 Basic Operations

### Single-click

If you use Electronic Pen, press the surface with the pen tip at proper strength.

If you use Electronic Wand, touch the surface with the wand tip, then press the interactive button on the wand body.

### Double-click

If you use Electronic Pen, press the surface twice with the pen tip at proper strength. Please make sure you press at the same point.

If you use Electronic Wand, touch the surface with the wand tip, then press the interactive button twice on the wand body.

### Right-click

If you use Electronic Pen, press the surface with the pen tip, and hold for 2 seconds to popup the right-click menu.

If you use Electronic Wand, touch the surface with the wand tip, then press and hold the interactive button on the wand body for 2 seconds.

### Drag

If you use pen or finger, press and hold an object with the pen tip, then move the pen tip to drag the object to the desired position.

If you use Electronic Wand, press the object with the wand tip, then press and hold the interactive button on the wand body, and move the wand tip to drag the object to the desired position.

### Write

If you use Electronic Pen, start IQBoard Software, select a drawing tool, then you can write or draw by pressing the surface with the pen tip.

If you use Electronic Wand, start IQBoard Software, select a drawing tool, then you can write or draw by pressing the surface with the wand tip, then pressing and holding the interactive button on the wand body.

## 7.2 How to Use Buttons on Electronic Pen

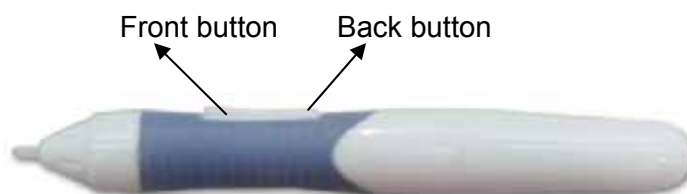

The Electronic Pen of IQBoard ET Pro & ET-D Pro has 2 multi-functional interactive buttons. You can achieve dozens of functions by simply pressing the interactive buttons. Following are the operations of these interactive buttons. When using these buttons, please touch the whiteboard surface gently with pen tip (you can keep the pen tip away from the surface 0-6 mm). Do not press the surface.

### 7.2.1 Settings on Button Functions

Select “*Start > Programs > IQBoard ET Pro & ET-D Pro Drivers > Button Function Settings*”, the setting window appears as follow:

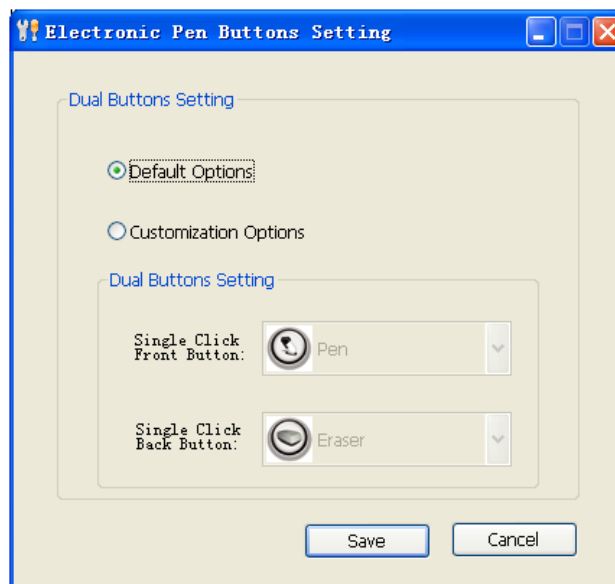

## 7.2.2 Default Options

### When in Windows Mode

Front button:

Like left-click function of Mouse, press once to execute single-click, twice to double-click, and hold to drag.

Back button:

Press the button once to execute right-click function of Mouse;

If IQBoard Software is not activated, press the button twice to activate IQBoard Software.

### When in Board Mode, annotating on desktop, Dual-user or Dual-pen Mode, playing page or reviewing operation

Front button:

If the “Select” function is not activated, press the button once to use the “Select” function;

If the “Select” function is not activated, press the button twice to use “Move Page” function, which can be used only in Board Mode;

If the “Select” function is activated, press the button once to execute left-click function of Mouse.

Back button:

If no Freehand Drawing Tool is selected, press the button once to select a Freehand Drawing Tool;

If no Freehand Drawing Tool or Eraser is selected, press the button twice to select an Eraser;

If any Freehand Drawing Tool is selected, press the button once to select an Eraser;

If any Eraser is selected, press the button once to select a Freehand Drawing Tool.

## 7.2.3 Customized Options

### When in Board Mode, annotating on desktop, Dual-user or Dual-pen Mode, playing page or reviewing operation

You can customize the single-click function of Front and Back buttons at your own will.



**Note:**

1. For IQBoard ET-D Pro, the button functions above are for Teacher Pen only.
2. You can enter the Dual-user or Dual-pen Mode only when IQBoard ET-D Pro Interactive Whiteboard is connected.
3. To know the details of the above mentioned modes and status, please refer to IQBoard Software V5.0 User Manual.
4. When you press the Back Button to select a Freehand Drawing Tool or an Eraser, the default Free Hand Drawing tool is Pencil, and the default Eraser is Normal Eraser. If you have selected other Freehand Drawing Tool or Eraser before, IQBoard Software will use your previous selections.

### 7.3 How to Use Frequently Used Soft Hotkeys

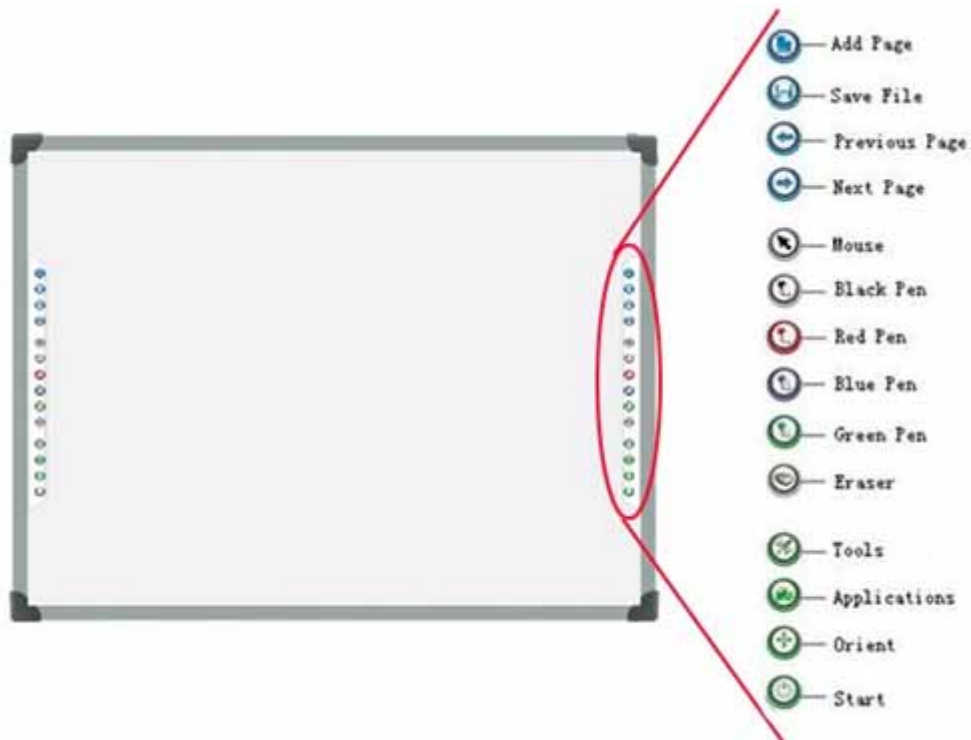



Following is the introduction of frequently used soft hotkeys:

**Add Page** : In Windows Mode, press this key to clear all annotations on screen. In Board Mode, press this key to add a new page in current .cdf file.

**Save File** : In Windows Mode, press this key to save all annotations on screen to a page in current file. In Board Mode, press this key to save the current .cdf file.

**Previous Page** : Press this key to go to the previous page.

**Next Page** : Press this key to go to the next page.

**Mouse** : Press this key, you can use electronic pen or writing pen (finger) to achieve click, double-click, and drag function. When using IQBoard Software, press this key to switch between Windows and Board Mode.

**Pen** : There are four “Pen” keys in different colors on the hotkey bar. Press one of these keys, you can write on the board in corresponding color. Press “Pen” twice to modify its properties.

**Eraser** : Press this key, you can erase the writing content on board. In “Windows” mode, press this key twice to popup the “Shut Down Windows” window.

**Tools** : Press this key to popup a quick access bar including shortcut icons for frequently used tools in IQBoard Software. You can add up to 8 shortcut icons in this bar.

**Applications** : Press this key to popup a quick access bar including shortcut icons for frequently used applications. You can add up to 8 shortcut icons in this bar.

**Start** : Press this key to start the IQBoard Software.

**Orient** : Press this key to popup the orientation interface.



**Note:**

1. Except the “Start” and “Orient” keys, all hotkeys are functional only after IQBoard Software is started.
2. The functions of “Frequently Used Tools”, “Frequently Used Applications” and “Orient” can be opened or closed by pressing the relevant hotkeys on the hotkey bar.
3. For IQBoard ET-D Pro, when in Dual-user Mode, the left hotkeys are for Teacher Pen, and the right for Student Pen. Teacher Pen can use the hotkeys including Mouse, 4 Freehand Drawing Tools, Eraser, Frequently Used Tools, Frequently Used Applications and Orient. Student Pen can use the hotkeys including Mouse, 4 Freehand Drawing Tools, Eraser, Frequently Used Tools and Frequently Used Applications.

# Chapter 8 FAQ

## **1. The whiteboard indicator is not lighting or turns red, or the hotkey is not functioning.**

1) The USB cable is not well connected with whiteboard or computer, please check and re-connect.

2) The USB port is damaged, please try another one. In case you are using desktop computer, please use its rear USB port.

3) If you use wireless connection, please make sure you have inserted the round terminal of the 5V transformer into a round jack on the right side of pen tray, inserted the power plug of the 5V transformer into a power socket, and well connected the wireless adapter and computer with USB cable.

4) IQBoard ET Pro & ET-D Pro Drivers haven't been correctly installed. Please uninstall the driver, restart computer, and re-install the driver. After the installation is completed, please reconnect the USB cable with computer.

5) IQBoard Software hasn't been started, please start IQBoard Software first.

## **2. What kind of orientation precision should I select?**

It depends on your requirement of orientation time and accuracy. You have the following choices:

Quick orientation (4 points): for fast orientation

Standard orientation (9 points): for most of situations

Precise orientation (20 points): for high-definition system

## **3. When operating and writing on the whiteboard, the position of pen doesn't match the position of cursor.**

1) The relevant location of projector and whiteboard has been changed. Please readjust the projection area, and then re-orient the whiteboard.

2) The projection area has trapezoid distortion, please adjust the projection area, and re-orient the whiteboard.

3) When orienting the whiteboard, the pen is not perpendicular to the surface, please re-orient with correct posture.

4) When orienting the whiteboard, the pen tip missed the green center of the red orienting cross, please re-orient the whiteboard.

**4. When I operate and write on the whiteboard, the system response is slow, or the stroke is intermittent.**

1) The computer is not under normal running or the memory is occupied too much. Please close some applications or restart the computer.

2) The operating or writing force is uneven. Sometimes the force is too light to be sensed.

3) The battery of Electronic Pen is running out, please replace new battery and try again.

4) The pen leans excessively when writing. Please keep the angle of inclination more than 40 ° .

**5. When I operate and write on the IQBoard ET Pro or ET-D Pro with electronic pen, the system doesn't respond.**

1) The electronic pen runs out of battery, please replace the battery.

2) The body of electronic pen is loose, please tighten it.

3) Please check whether the whiteboard indicator is green, if not, please refer to the solution of Question 1.

**6. When using IQBoard ET Pro or ET-D Pro, the cursor is out of gear or the whiteboard can't be oriented.**

There is interference source nearby, such as high voltage cable or large generator set which can generate strong magnetic field.

**Background knowledge:** IQBoard ET Pro & ET-D Pro adopt working principle of electromagnetic induction. So if there is interference source nearby that can generate strong magnetic field, the above symptom will occur. In normal condition, devices like cell phone, display and TV won't affect IQBoard ET Pro & ET-D Pro. In case the interfering magnetic field is too strong, you can move either the interference source or IQBoard ET Pro & ET-D Pro to keep their distance over 50cm.

**7. The pen tip is worn out.**

Common abrasion will not affect normal operation. When the pen tip is severely abraded, you can purchase it from local dealer.

**For other questions, please consult our service center or local dealer.**

# Chapter 9 Cautions and Maintenance

## 9.1 Whiteboard

For the interactive whiteboard that do not support normal marker (no “W” included in the product model), please try not to use normal marker to write on the surface. Before cleaning, please shut down the computer and switch the projector into standby mode to make the dirt more obvious. In case of normal dirt, spray some water or detergent on the surface, then use the paper to wipe the dirt out. If you leave some ink trail by mistakenly using the fountain pen, please buy some special whiteboard detergent and spray it on the soft cloth to clean the surface. For cleaning the mark left by the permanent marker, first paint some ink of dry erase marker on the mark (the ink of dry erase marker can dissolve the ink of permanent marker), then use soft cloth to clean. If the mark still exists, spray some whiteboard detergent, and clean it out.



**Note:** Please do not use other organic solvent for cleaning. Otherwise it may permanently damage the surface.

For the interactive whiteboard that supports normal marker, you can use normal whiteboard eraser and wet cloth to clean.



**Note:** Clean the frequently used whiteboard once a week to keep the best definition.

Please do not use sharp or pointed objects to scratch the surface and frame, otherwise the scratched part may be damaged, and won't work normally. During the usage, do not knock or press the surface fiercely with your pen or wand to avoid the damage of whiteboard surface, pen and wand. You can use sand wax to eliminate the scratch on the surface, and use dry cloth to clean out.

Since the mobile stand (or the wall hanging parts) is designed only to support the weight of the whiteboard, please do not put the additional weight or pressure on the whiteboard. Please keep the whiteboard away from intense collision, shaking, pressing and do not install it by force, otherwise it may cause cracking, short circuit and surface distortion.

Please do not use and install interactive whiteboard in dusty, foggy, wet and inclement environment. Keep it away from sharp object, heat source, corrosive chemicals, fire,

and water. Please do not put the whiteboard in the outlet of hot air, otherwise the material will deteriorate and its life-span will be shortened.

To avoid harm from improper operation, please do not use chair or other tool to help short students use the whiteboard. If students are not tall enough to use the whiteboard, please low down the whiteboard under the help of the professional technician.

## **9.2 USB Cable**

Do not put the USB cables on the floor where people might stumble over them. If you have to do so, straighten them and use insulated adhesive tape or cable with contrast color to tie them up. Please don't bend the USB cable excessively. Exposing the USB cable outside for a long time may shorten its life-span and cause other unnecessary damages, so please keep it carefully. If you use the whiteboard in the meeting room or classroom, please fix the cable along the cable alley.

## **9.3 Projection**

Face the whiteboard when operating and writing on the projected image, stand aside when you turn back to face the students. Please do not look at the projector directly to avoid its strong light damaging your eyesight. Instruct students how to use the whiteboard, tell them not to face the projector directly.

## **9.4 Transport**

Please handle with care, and do not put any weight on the surface so as to avoid the surface distortion and damage. Lay the whiteboard upright during the transportation or storage. For long distant transportation, it is suggested to repack the whiteboard with the original packing. If the original packing is unavailable, insert some protective padding between the components to protect them from intense vibration or crash. Please avoid vibration, dampness, electricity, water and pressure in transportation.

## **9.5 Part Replacement**

Please do not disassemble the whiteboard or modify its inner structure so as to prevent accident or trouble. For maintenance or part replacement, please resort to our authorized technician. Make sure that you use our designated part or the one with the same specification when replacing.